

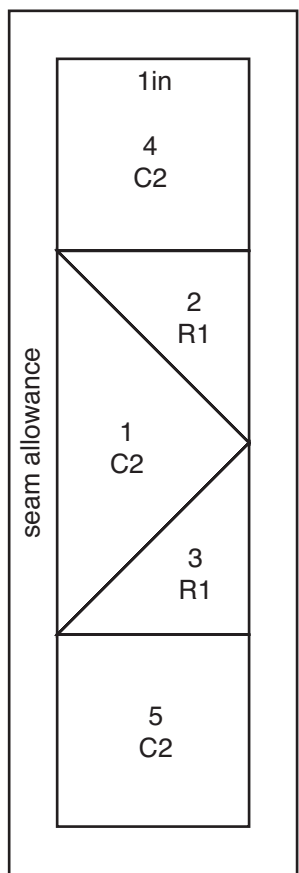

We have printed this sheet on one side only so you can put it against a window or lightbox and trace the templates easily.

Full size templates are here for:

- ◆ Kiku Kahei Fan Quilt
- ◆ Christmas Medallion Wall hanging
- ◆ Leaf Tablemats including bonus leaf patterns

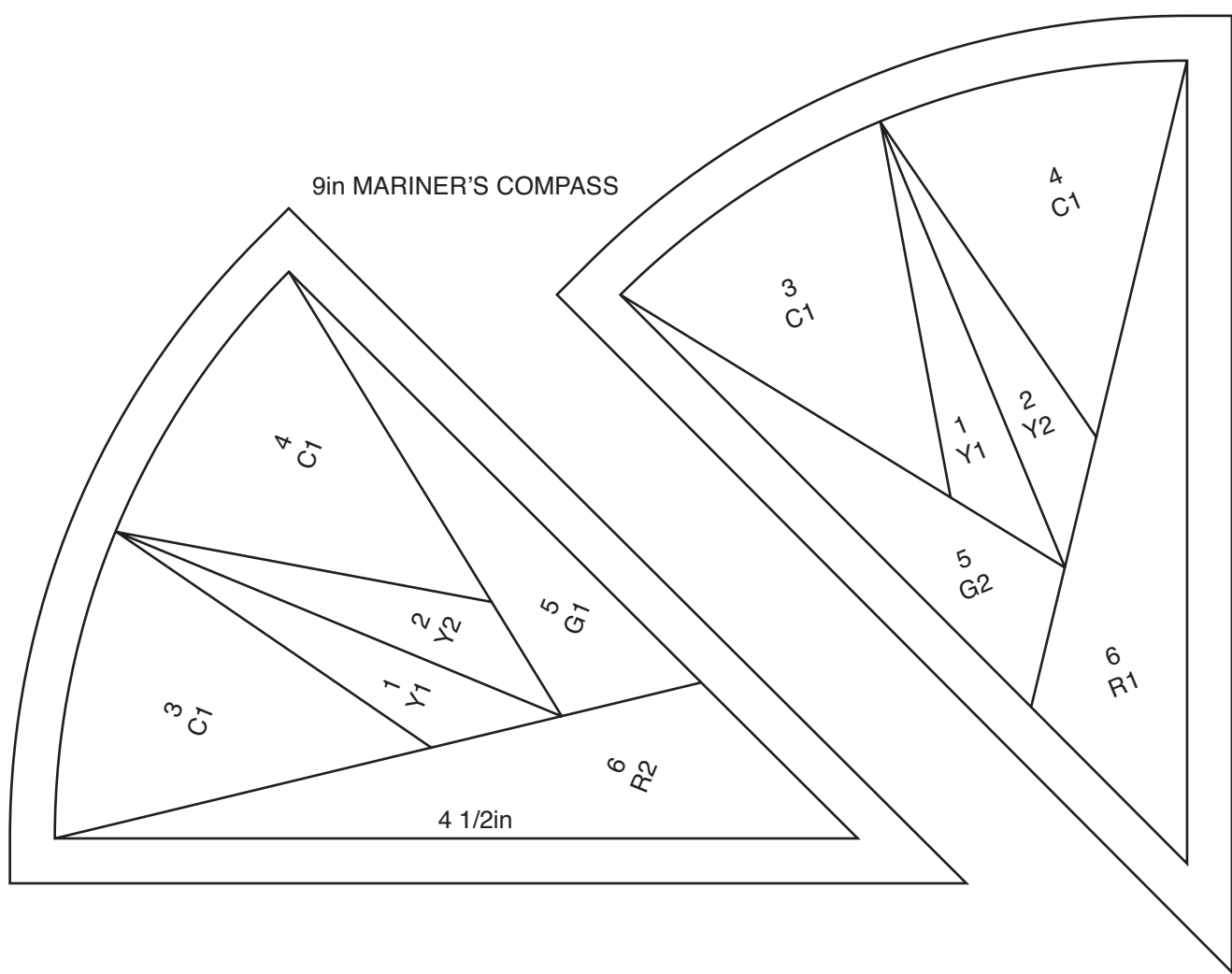

4in SAWTOOTH STAR

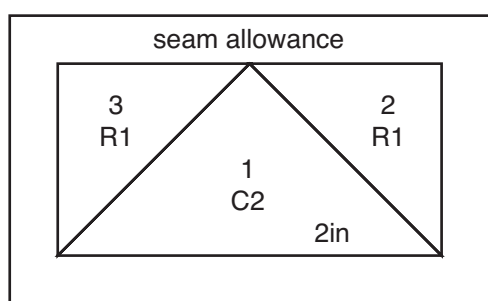
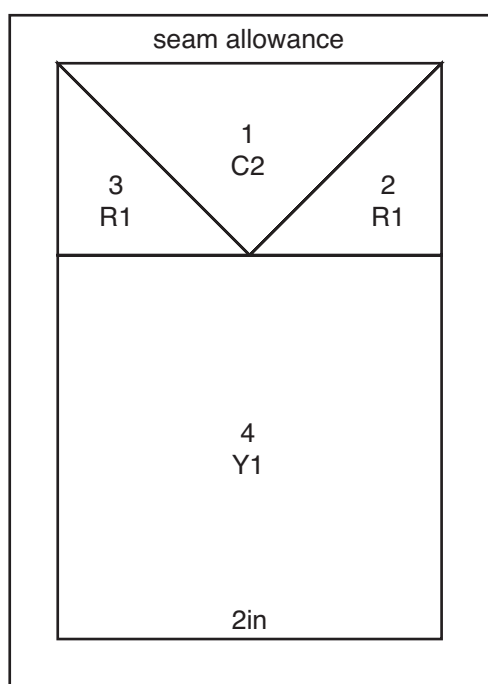

CHRISTMAS MEDALLION QUILT TEMPLATES
SHOWN AT 100%

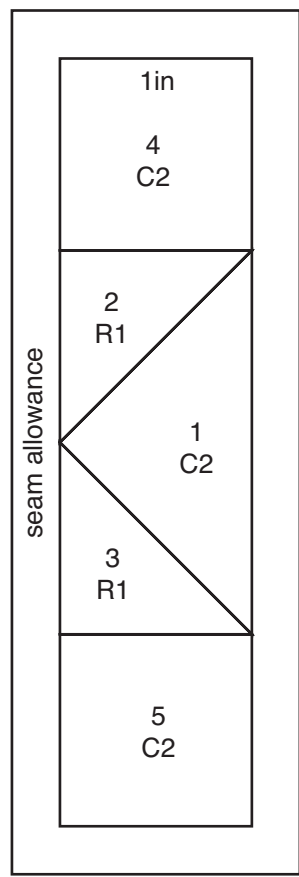

TURNING LEAF PROJECTS TEMPLATES
SHOWN AT 100%

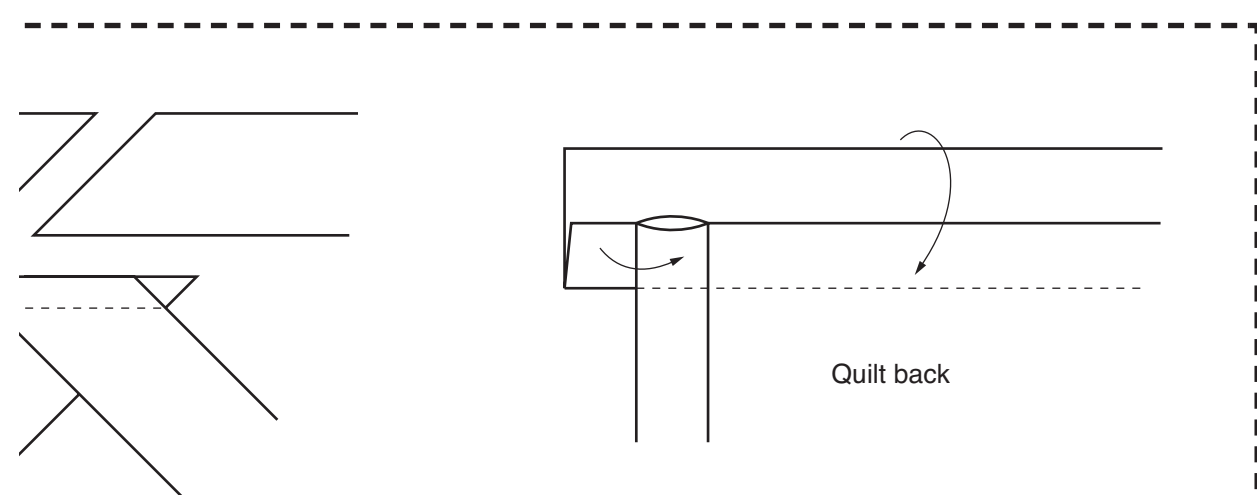
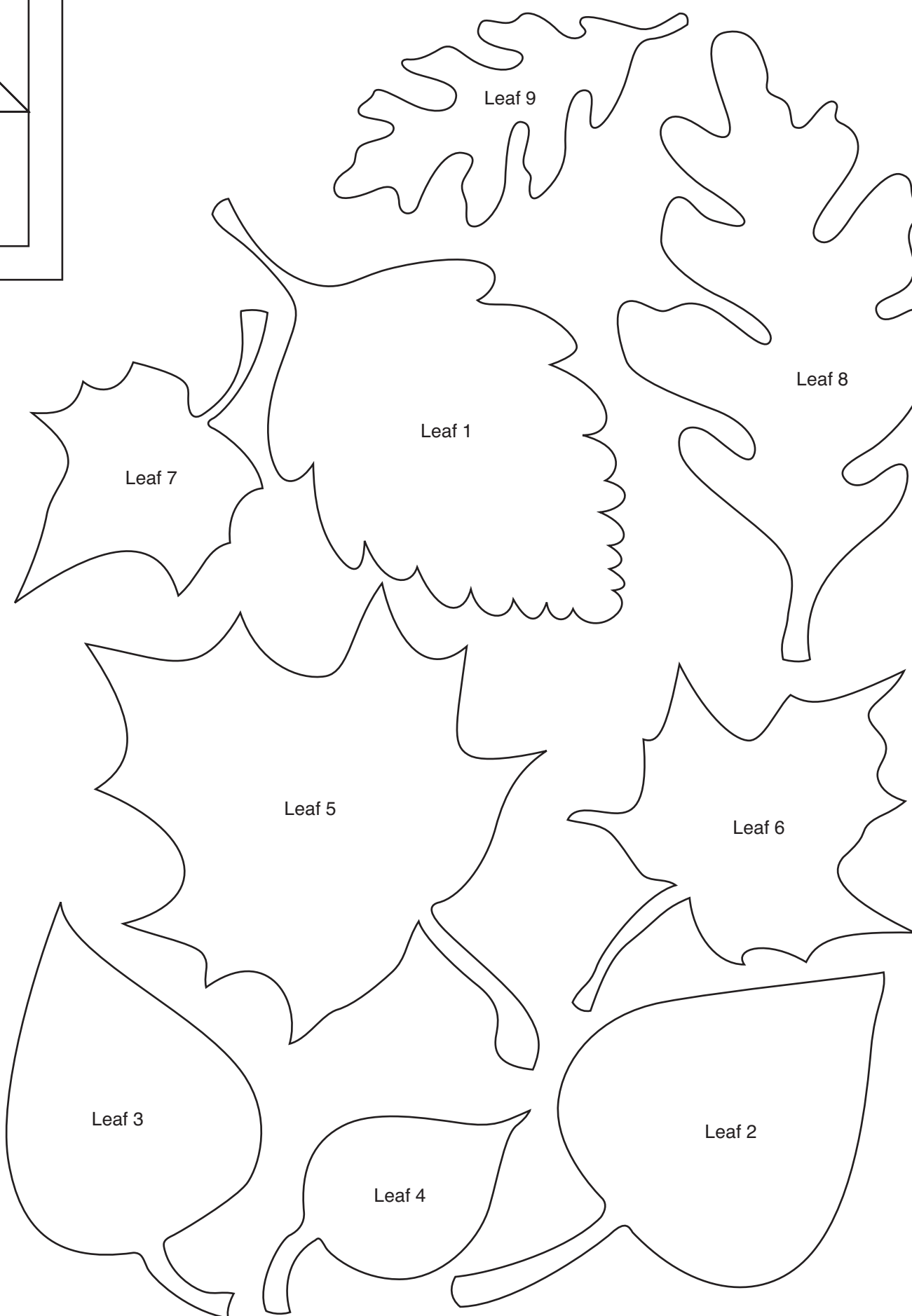

BUTTED CORNER (BELOW)

For a butted corner the first two sides match the quilt length, the last two sides are cut a little longer and then wrapped to the back as shown.

INDING
ias gives less bulk on the seam
1 too.

HOW TO MITRE A CORNER

a) Join the binding into one length with bias seams as shown above. Sew along one side stopping 1/4in from the corner.

b) Fold the fabric away from the corner

c) Fold back on itself in line with the next edge, start sewing from the corner.

d) Hand stitch to the back of your quilt and add a couple of stitches to the mitre too.

